

特性:

一,电气性能: EICTRICAL

1. 额定电流: 5.0A
2. 接触阻抗: 40 MILLIOHMS MAX
3. 耐压: 150V AC / 1 mA MAX
4. 绝缘阻抗: 150V DC/100 MEGA OHMS MIN

二,机械性能:

1. 插入力: 5~20N
2. 拔出力: 8~20N
3. 使用寿命: 10000次, 拔出力 6N MIN

三,材料: MATERIAL

1. 塑胶: LCP/PA9T UL94V-0
2. 端子: C7025/C18400 T=0.15MM
3. 外壳: SUS304 T=0.30MM
4. 卡勾: SUS304 T=0.15MM

四,电镀: FINISH

1. 端子: 接触点镀金3U"MIN
PIN脚焊接区域镀金1U"MIN.
2. 外壳: 镀镍50U"MIN (盐雾48H)

- 五,电镀品需做粘锡测试: 粘锡面积达到95%以上.
- 六, SMT回流焊 (峰值260°C±5°C) 不能起泡, 熔胶, 变色不良 (变形在公差范围以内)

- 七, 工作温度: -40°C~+85°C

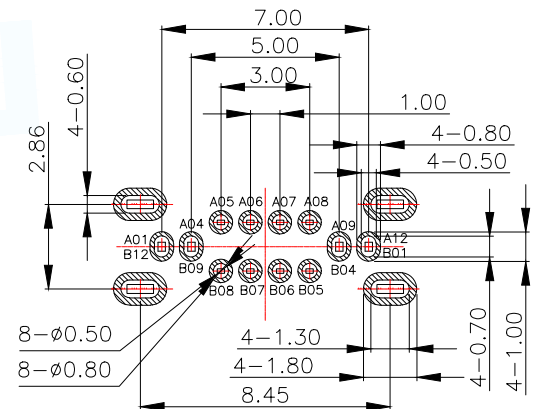

A1	GND	B12	GND
A4	VBUS	B9	VBUS
A5	CC1	B8	SBU2
A6	D+	B7	D-
A7	D-	B6	D+
A8	SBU1	B5	CC2
A9	VBUS	B4	VBUS
A12	GND	B1	GND
PIN	SIGNAL NAME	PIN	SIGNAL NAME

MANUFACTURE DWG		东莞市讯普电子科技有限公司 DongGuan XunPu Electronics Co., Ltd	
UNLESS OTHERWISE SPECIFIED TOLERANCES			TITLE: TYPE-C 16PIN 母座 立插 A款 H=12.4
DECIMALS:	ANGLES:		PAR TYPE-C-602-LDRH124
.X:±0.30	X.:±10°		DWN
.XX:±0.20	.X':±8°		CHKD
.XXX:±0.10		APVD	SCALE 1:1 UNIT:MM
CUSTOMER COPY		SIZE:A4	SHEET:1F1
			REV:A

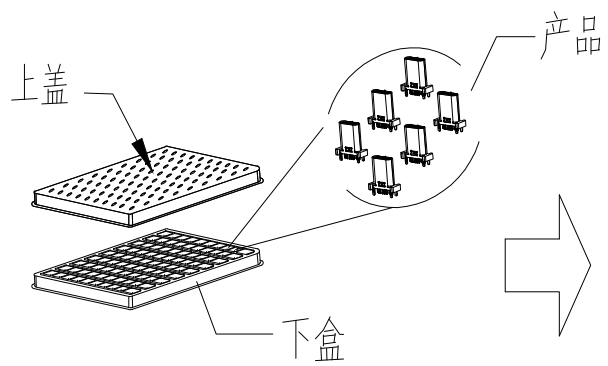

① PE真空盒(1Set).

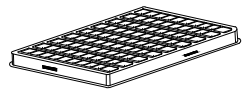

② 100PCS/盒

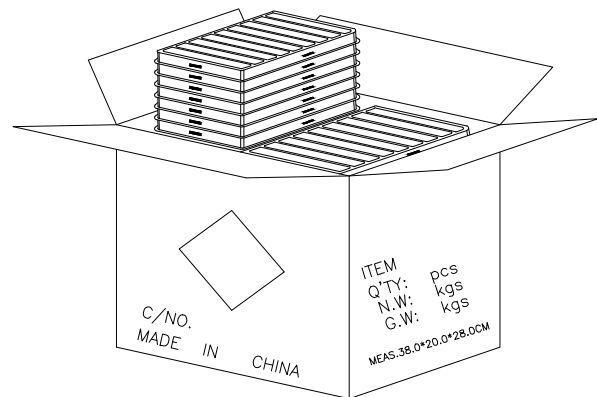

③ 50盒/箱(5k).

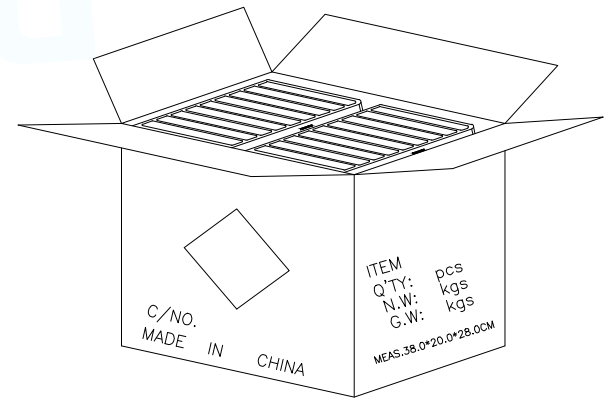

④ 每箱竖放25盒*2,若尾数箱在空间处
加装填充物.

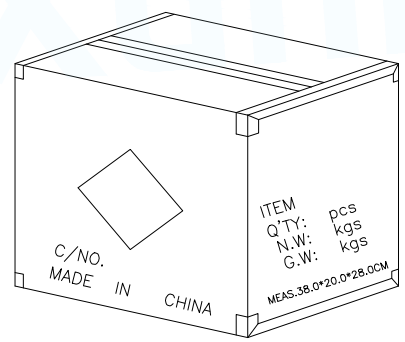

⑤ 外箱用透明胶纸带封”工”字型.

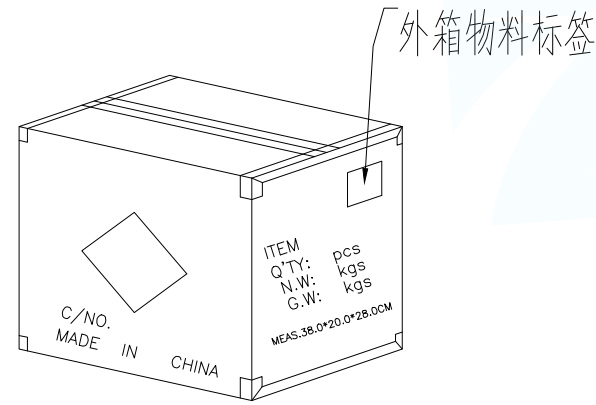

⑥ 依图示粘贴产品或ROHS标签.

备注:

1. PE真空盒1set
2. 每盒装成品100Pcs,四周并用订书机装订;
3. 每箱数量见表一
4. 外箱尺寸与规格:38*20*28CM
5. 外箱用透明胶纸带封”工”字型;

MANUFACTURE DWG		东莞市讯普电子科技有限公司 DongGuan XunPu Electronics Co.,Ltd	
UNLESS OTHERWISE SPECIFIED TOLERANCES			TITLE:TYPE-C 16PIN 母座 立插 A款 H=12.4 包装图
DECIMALS:	ANGLES:		PAR TYPE-C-602-LDRH124
.X:±0.30	X.:±10°		DWN
.XX:±0.20	.X':±8°		CHKD
.XXX:±0.10		APVD	SCALE:1:1 UNIT:MM
CUSTOMER COPY		SIZE:A4	SHEET:1F1
			REV:A