

NOTES:

- ELECTRICAL SPECIFICATIONS:  
CURRENT RATING: 0.5A.  
VOLTAGE RATING: 5V.  
CONTACT RESISTANCE: 50 MILL.OHM MAX.  
INSULATION RESISTANCE: 1000 MEG.OHM MIN.
- MECHANICAL SPECIFICATIONS:  
DURABILITY: 5000 CYCLES MIN.

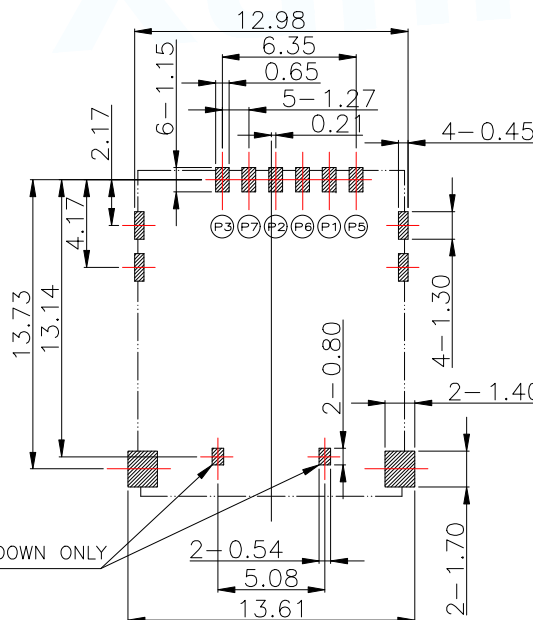
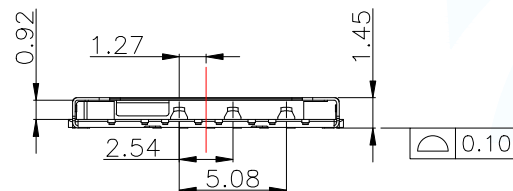

NOT GND  
FOR HOLD-DOWN ONLY

RECOMMENDED PCB LAYOUT  
GENERAL TOLERANCE ±0.05

MICRO SIM CARD	
Pin No.	NAME
P1	VCC OF SIM
P2	RST OF SIM
P3	CLK OF SIM
P5	GND OF SIM
P6	VPP OF SIM
P7	I/O OF SIM
P4/P8	N/A

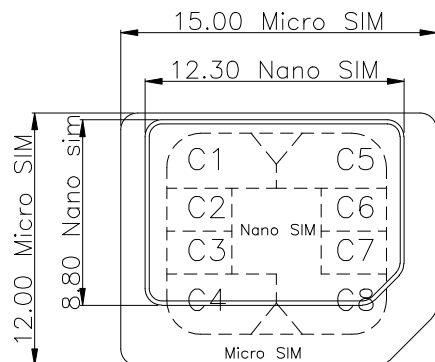

MANUFACTURE DWG			东莞市讯普电子科技有限公司 DongGuan XunPu Electronics Co.,Ltd	
UNLESS OTHERWISE SPECIFIED TOLERANCES			TITLE: MICRO SIM CARD CONNECTOR H1.45	
DECIMALS:	ANGLES:	PAR	SMC-204-ARP6	
X.:±0.45	X':±5°	DWN		
X.X:±0.35	X.X':±2°	CHKD		
X.XX:±0.25		APVD		
CUSTOMER COPY		SCALE1:1	UNIT:MM	
		SIZE:A4	SHEET:1F1	REV:A

<图一>

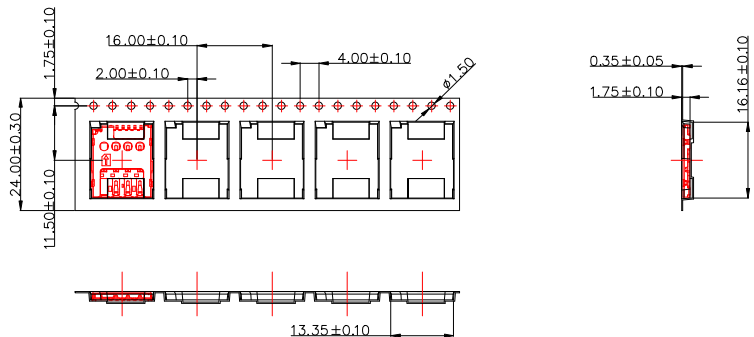

DETAIL A

放料方向

<图二>

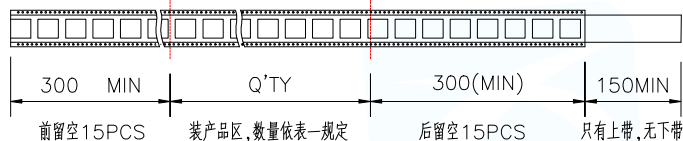

<表一>

包装数量		
PCS/卷	卷/箱	PCS/箱
1500	11	16500

<图三>

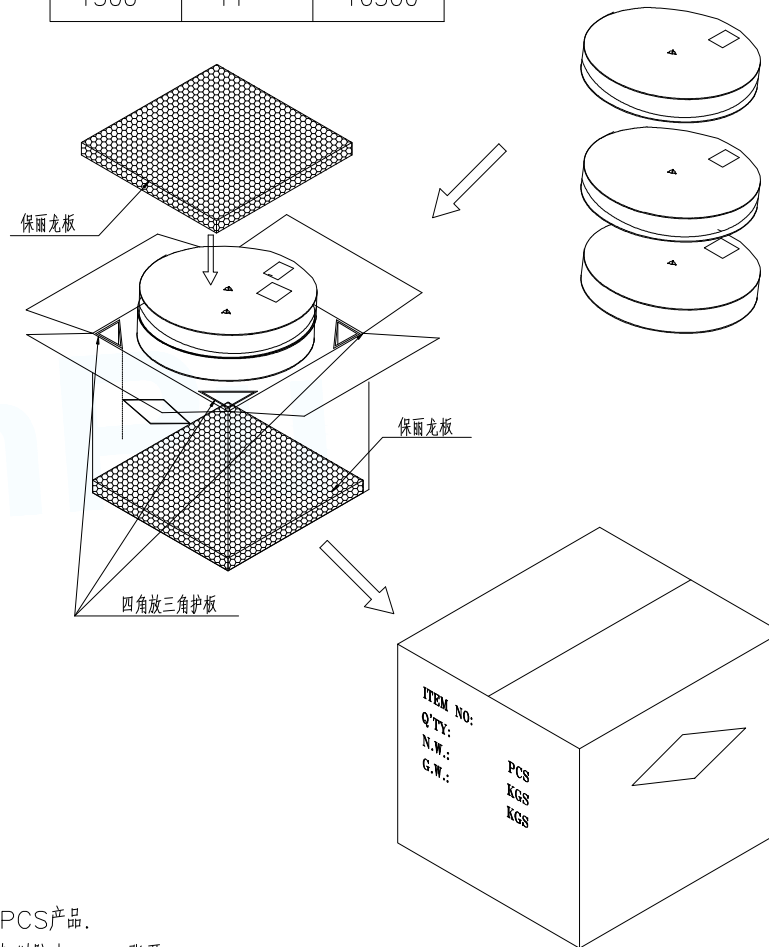

28.4 REF.

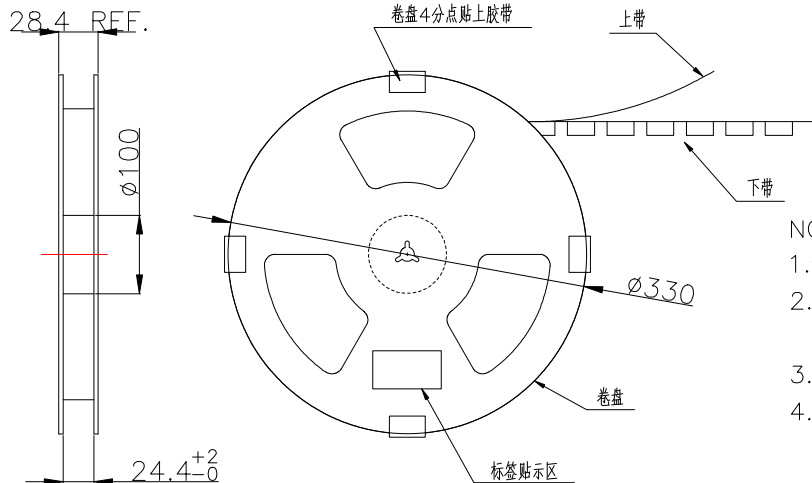

NOTE:

- 依<图一>示放置产品于下载中, 每穴放置1PCS产品.
- 包装机包好后, 在REEL的个等分点贴上胶带, 以防止REEL张开, 每REEL贴1PCS标签, 如<图二>示
- 包装数量见如<表一>示
- 包装成箱见如<图三>示  
箱底放保丽龙板, 再依次将指定数量的卷装产品放入箱内, 四角分别放入四个三角护板, 最上层再放上保丽龙板.
- 封箱, 在封好的纸箱上按客户要求写上料号, 数量等
- 适用成品料号见如下<表二>

MANUFACTURE DWG		东莞市讯普电子科技有限公司 DongGuan XunPu Electronics Co., Ltd	
UNLESS OTHERWISE SPECIFIED TOLERANCES			TITLE: MICRO SIM CARD CONNECTOR H1.45
DECIMALS:	ANGLES:		PAR: SMC-204-ARP6
X.: ±0.45	X'.': ±5°		DWN:
X.X: ±0.35	X.X': ±2°		CHKD: APVD
X.XX: ±0.25		CUSTOMER COPY	SCALE 1:1 UNIT: MM SIZE: A4 SHEET: 1F1 REV: A